

JETTEC REC EC

wentylatory kanałowe



konstrukcja

Konstrukcja składa się z wentylatora diagonalnego z silnikiem EC zabudowanego w prostokątnej obudowie (w części modeli występują dwa wentylatory pracujące równocześnie). Specjalnie zaprojektowana obudowa (podwójna warstwa blachy stalowej) zapewnia dużo lepszą redukcję hałasu emitowanego do otoczenia niż konstrukcje standardowe. Dzięki zastosowaniu energooszczędnych wentylatorów EC typu mix-flow uzyskano znacznie bardziej kompaktowe wymiary obudowy, mniejsze zużycie energii elektrycznej, jak również ograniczono straty ciśnienia strumienia przepływającego powietrza, w porównaniu do standardowych wentylatorów z wirnikami promieniowymi. Po zdjęciu pokrywy, sekcję wentylatora można w całości wymontować, w celu przeprowadzenia prac serwisowych.

wirnik

Wyważany dynamicznie wirnik diagonalny z tworzywa sztucznego z pierścieniem zewnętrznym eliminującym straty ciśnienia wywołane turbulentnym przepływem na końcach łopatek. Łopatki profilowane w celu zachowania jak najmniej turbulentnego przepływu, umieszczone na stożkowej piaście konfuzora, dzięki któremu zasysane powietrze kierowane jest na najbardziej efektywną część łopatki.

napęd i sterowanie

Napęd stanowi silnik elektryczny komutowany elektronicznie (EC) ze zintegrowanym kontrolerem i zabezpieczeniem termicznym. Zasilanie 230V ~1, 50Hz. Silniki przystosowane są do płynnej regulacji prędkości obrotowej w pełnym zakresie przy zachowaniu wysokiej sprawności. Zmiana prędkości obrotowej odbywa się poprzez podłączenie potencjometru lub innego urządzenia (sterownika) wykorzystującego sygnał analogowy 0-10V. Stopień ochrony urządzenia IPX4, silnika IP33. Klasa izolacji F.

maksymalna temperatura pracy

35 ÷ 60°C - w zależności od wybranego modelu.



Podłączenie elektryczne

Odpowiednio zabezpieczona kostka podłączeniowa pozwala na bezpieczne i wygodne uruchomienie urządzenia.

Akcesoria



GS
wyłącznik serwisowy
str. nr 548



CON P-1000
regulator stałego ciśnienia
str. nr 545



MTP 10 / MTV-010
potencjometr
str. nr 529



VS
złącze przeciwdrganiami
str. nr 94



VKK
żaluzja grawitacyjna
str. nr 97



Stabilny przepływ

Unikalne kierownice dyfuzora wyrównują strugę powietrza za wentylatorem i redukują straty ciśnienia do minimum.



Konserwacja

Dostęp do wnętrza wentylatora umożliwia zdejmowana pokrywa.



Niski hałas

Najwyższa efektywność aerodynamiczna powoduje redukcję emitowanego hałasu.

TECHNOLOGIA EC



Wentylatory JETTEC REC EC wyposażone zostały w nowoczesne silniki komutowane elektronicznie EC. Ich zaletą jest łatwa i płynna regulacja prędkości obrotowej w pełnym zakresie, przy jednoczesnym zachowaniu wysokiej efektywności pracy.

tablica doboru akcesoriów dla danego wentylatora JETTEC REC EC

Typ JETTEC REC EC	50/25/2100EC	50/30/2300EC	60/30/2300EC	60/30/4500EC	60/35/2700EC	60/35/4600EC
wyłącznik serwisowy	GS 03	GS 03	GS 03	GS 03	GS 03	GS 03
potencjometr	MTP 10/MTV-010	MTP 10/MTV-010	MTP 10/MTV-010	MTP 10/MTV-010	MTP 10/MTV-010	MTP 10/MTV-010
regulator stałego ciśnienia	CON P-1000	CON P-1000	CON P-1000	CON P-1000	CON P-1000	CON P-1000
złącze przeciwdrganiami	VS 5025	VS 5030	VS 6030	VS 6030	VS 6035	VS 6035
żaluzja grawitacyjna	VKK 5025	VKK 5030	VKK 6030	VKK 6030	VKK 6035	VKK 6035

Typ JETTEC REC EC	60/35/4400EC	60/35/3000EC	70/40/5500EC	80/50/6100EC	80/50/8900EC	100/50/10400EC
wyłącznik serwisowy	GS 03	GS 03	GS 03	GS 03	GS 03	GS 03
potencjometr	MTP 10/MTV-010	MTP 10/MTV-010	MTP 10/MTV-010	MTP 10/MTV-010	MTP 10/MTV-010	MTP 10/MTV-010
regulator stałego ciśnienia	CON P-1000	CON P-1000	CON P-1000	CON P-1000	CON P-1000	CON P-1000
złącze przeciwdrganiami	VS 6035	VS 6035	VS 7040	VS 8050	VS 8050	VS 10050
żaluzja grawitacyjna	VKK 6035	VKK 6035	VKK 7040	VKK 8050	VKK 8050	VKK 10050

dane techniczne

Typ	\dot{V}_{max} [m ³ /h]	Δp_{max} [Pa]	P_{max} [W]	$U_n / U_{ster.}$ [V] / [V]	I_{max} [A]	RPM_{max} [1/min]	t_{max} [dB(A)]	L_{WA} [dB(A)]	L_{pA} [°C]	m [kg]	nr katalogowy
JETTEC REC 50/25/2100EC	2100	750	306	230,1~/0-10	2,1	3850	45	65	58	10	13674100
JETTEC REC 50/30/2300EC	2330	650	269	230,1~/0-10	1,9	3220	45	71	64	11,9	13674200
JETTEC REC 60/30/2300EC	2300	645	270	230,1~/0-10	1,9	3240	45	67	60	13	13674400
JETTEC REC 60/30/4500EC	4500	640	534	230,1~/0-10	3,7	3220	60	65	58	18,5	13674300
JETTEC REC 60/35/2700EC	2720	580	282	230,1~/0-10	2	2800	45	53	46	13,4	13674600
JETTEC REC 60/35/4600EC	4580	640	534	230,1~/0-10	3,7	3220	45	61	54	18,9	13674500
JETTEC REC 60/35/4400EC	4390	920	716	230,1~/0-10	3,3	3010	60	64	57	17,5	13675200
JETTEC REC 60/35/3000EC	3050	475	264	230,1~/0-10	1,9	2210	35	55	48	16	13674700
JETTEC REC 70/40/5500EC	5530	595	572	230,1~/0-10	3,9	2800	45	57	50	21,6	13674800
JETTEC REC 80/50/6100EC	6140	470	535	230,1~/0-10	3,7	2210	35	55	48	27	13675000
JETTEC REC 80/50/8900EC	8890	920	1456	230,1~/0-10	6,7	3000	60	61	54	30,6	13674900
JETTEC REC 100/50/10400EC	10410	840	1462	230,1~/0-10	6,7	2630	60	68	61	38	13675100

wymiary

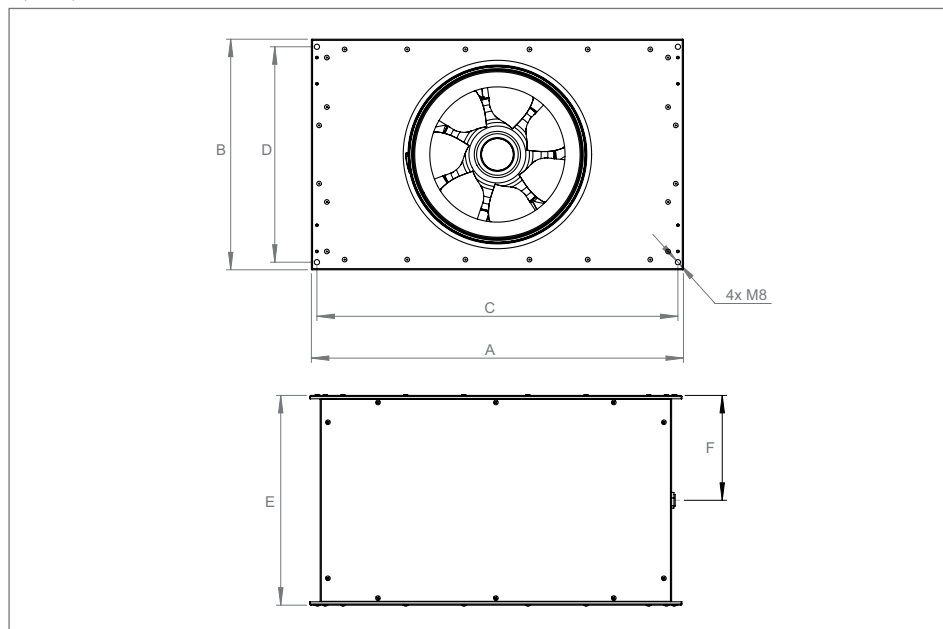

schemat elektryczny

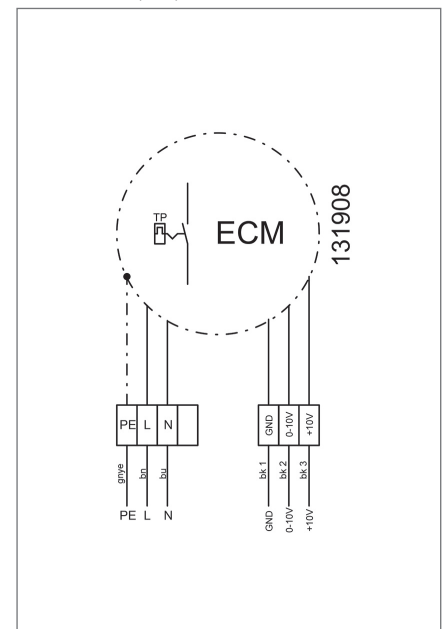

Typ	A [mm]	B [mm]	C [mm]	D [mm]	E [mm]	F [mm]
JETTEC REC50/25/2100EC	538	300	520	270	285	142,5
JETTEC REC 50/30/2300EC	538	338	520	320	350	175
JETTEC REC 60/30/2300EC	639	338	620	320	353	176,5
JETTEC REC 60/30/4500EC	639	338	620	320	353	176,5
JETTEC REC 60/35/2700EC	639	396	620	370	360	180
JETTEC REC 60/35/4600EC	639	396	620	370	360	180
JETTEC REC 60/35/4400EC	639	396	620	370	360	180
JETTEC REC 60/35/3000EC	639	396	620	370	360	180
JETTEC REC 70/40/5500EC	738	438	720	420	360	180
JETTEC REC 80/50/6100EC	838	538	820	520	362	181
JETTEC REC 80/50/8900EC	838	538	820	520	362	181
JETTEC REC 100/50/10400EC	1038	538	1020	520	401	200,5

charakterystyki pracy

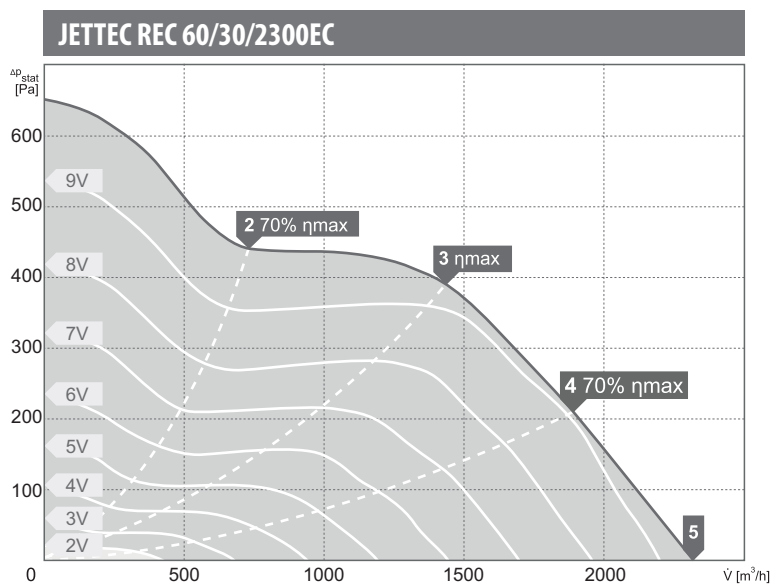
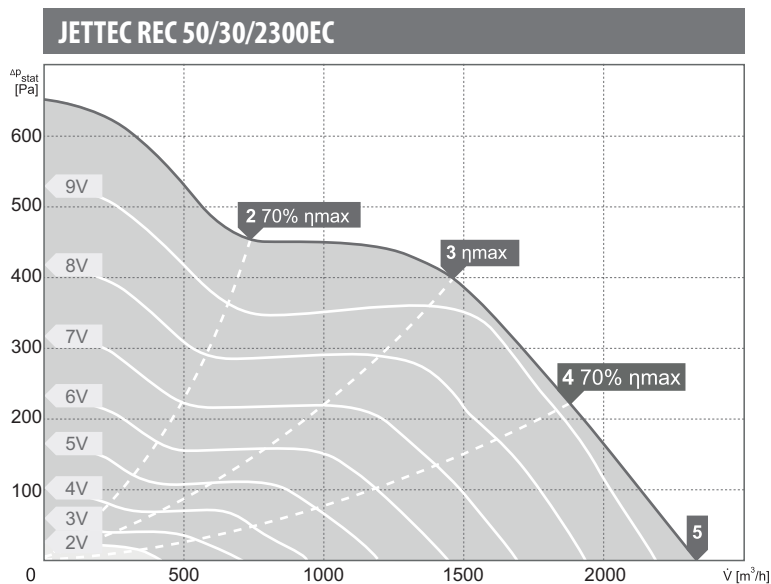
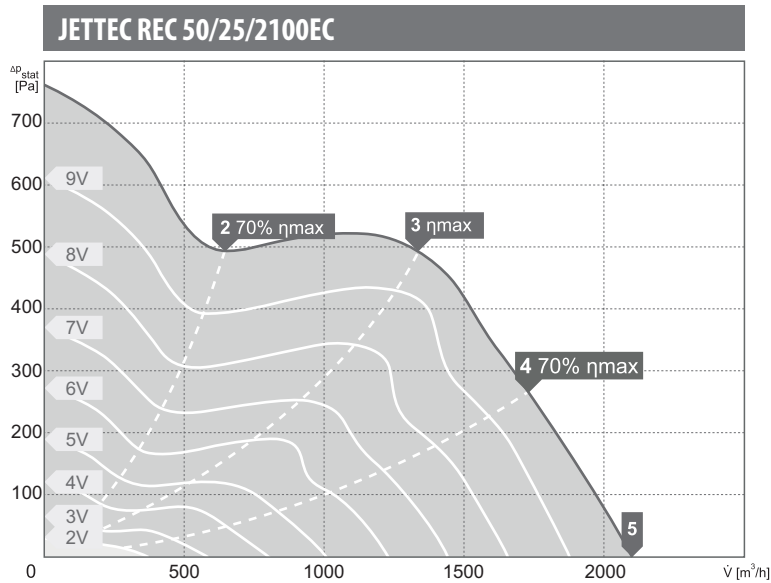

wartości mocy akustycznej L_{WA} [dB(A)]

dla poszczególnych częstotliwości pasm oktaowych [Hz]

Pkt. Pracy	tot	Częstotliwości pasm oktaowych [Hz]							
		63	125	250	500	1000	2000	4000	8000
L_{WA} wlot [dB(A)]									
2	82	57	70	70	76	78	75	70	61
3	80	42	48	61	74	76	74	68	63
4	82	46	47	60	77	77	76	70	65
5	84	49	50	62	79	79	78	73	68
L_{WA} wylot [dB(A)]									
2	85	58	68	72	77	82	79	73	66
3	85	56	69	73	78	82	79	72	64
4	81	41	44	58	70	76	76	71	66
5	83	42	48	61	73	80	78	75	69
L_{WA} od obudowy [dB(A)]									
2	68	59	65	60	50	56	55	51	46
3	65	53	53	62	47	55	53	50	46
4	64	53	52	62	49	55	55	51	46
5	65	59	47	59	49	57	56	54	50

Pkt. Pracy	tot	Częstotliwości pasm oktaowych [Hz]							
		63	125	250	500	1000	2000	4000	8000
L_{WA} wlot [dB(A)]									
2	82	56	68	68	75	79	74	69	60
3	82	52	65	69	76	79	74	69	59
4	81	40	49	65	71	79	72	70	62
5	82	39	49	61	72	80	75	72	66
L_{WA} wylot [dB(A)]									
2	81	60	71	74	81	85	80	74	65
3	81	52	68	75	82	85	80	74	64
4	78	45	52	71	79	83	78	74	67
5	83	47	55	69	82	88	83	79	74
L_{WA} od obudowy [dB(A)]									
2	73	61	69	59	56	68	61	57	49
3	71	58	66	58	56	68	61	58	50
4	66	47	52	50	51	64	60	58	52
5	70	51	54	50	53	67	63	61	56

Pkt. Pracy	tot	Częstotliwości pasm oktaowych [Hz]							
		63	125	250	500	1000	2000	4000	8000
L_{WA} wlot [dB(A)]									
2	82	56	67	68	75	79	74	69	60
3	82	52	65	69	76	79	74	69	59
4	80	41	48	64	70	78	72	70	63
5	82	39	49	61	72	80	75	72	66
L_{WA} wylot [dB(A)]									
2	84	57	68	71	77	81	76	70	62
3	84	52	67	72	78	81	76	70	60
4	82	43	50	67	75	79	74	70	63
5	84	40	49	64	76	82	77	73	68
L_{WA} od obudowy [dB(A)]									
2	69	56	59	55	52	68	50	46	39
3	67	51	56	53	49	66	48	41	35
4	59	43	38	44	45	57	50	40	37
5	59	38	41	44	47	58	48	42	39

charakterystyki pracy

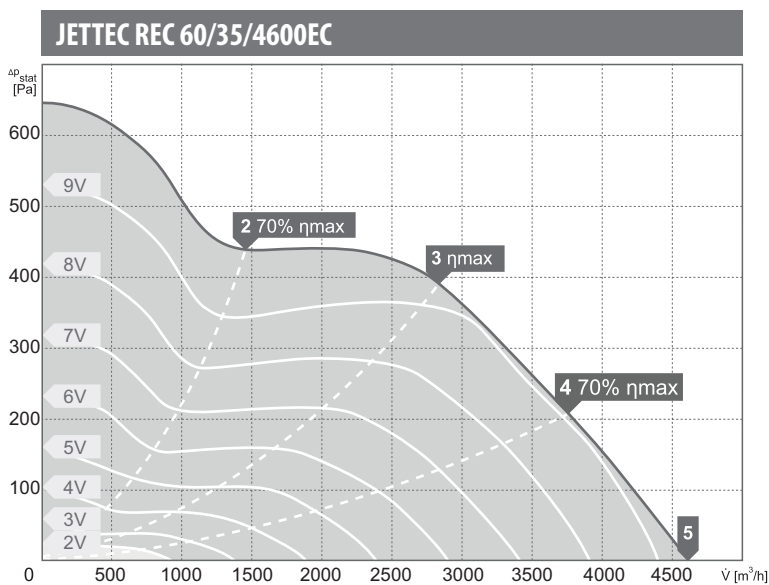
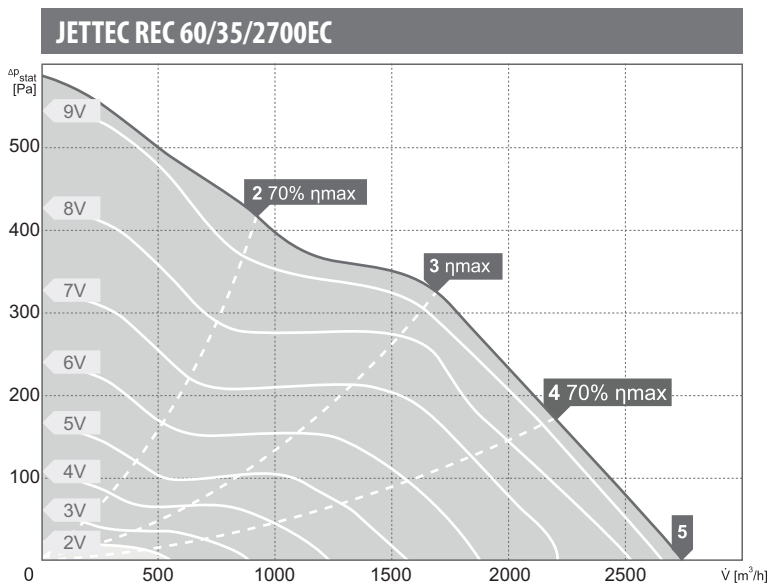
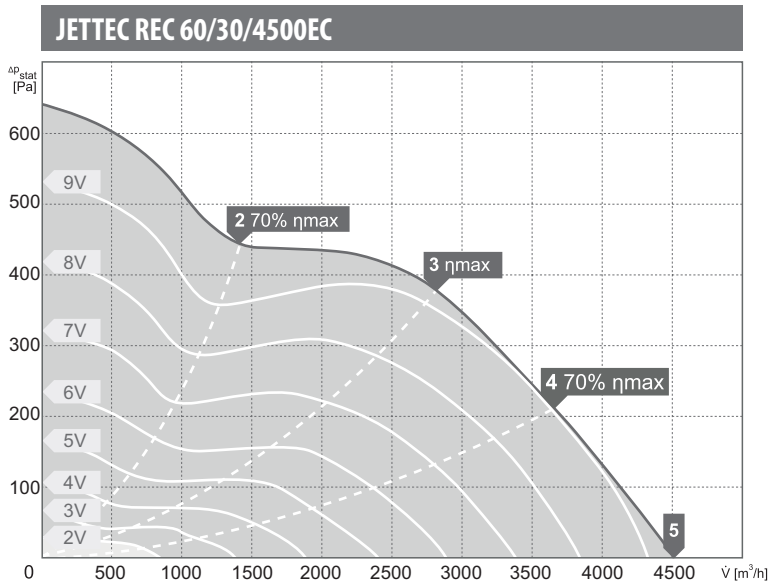

wartości mocy akustycznej L_{WA} [dB(A)]
dla poszczególnych częstotliwości pasm oktaowych [Hz]

Pkt. Pracy	Częstotliwości pasm oktaowych [Hz]								
	tot	63	125	250	500	1000	2000	4000	8000
L_{WA} wlot [dB(A)]									
2	84	58	69	72	78	81	75	70	62
3	83	53	54	70	76	81	75	72	65
4	84	49	50	70	74	81	77	73	66
5	86	51	52	70	77	84	80	75	69
L_{WA} wylot [dB(A)]									
2	86	58	71	74	79	83	79	73	64
3	85	51	57	71	78	81	78	74	66
4	85	49	53	71	77	81	79	75	68
5	88	49	54	71	79	84	82	77	71
L_{WA} od obudowy [dB(A)]									
2	70	56	61	59	57	68	52	52	49
3	65	49	49	55	54	63	49	49	46
4	64	49	49	56	55	62	50	47	41
5	67	47	52	59	59	65	53	48	42

Pkt. Pracy	Częstotliwości pasm oktaowych [Hz]								
	tot	63	125	250	500	1000	2000	4000	8000
L_{WA} wlot [dB(A)]									
2	78	56	69	72	78	79	76	71	61
3	75	38	55	68	72	75	73	72	63
4	74	35	49	63	70	75	73	73	64
5	76	40	51	66	72	77	75	75	67
L_{WA} wylot [dB(A)]									
2	83	57	69	72	78	79	75	69	59
3	81	41	56	70	76	77	74	70	60
4	79	32	47	67	73	75	72	70	62
5	82	33	48	64	76	77	74	72	65
L_{WA} od obudowy [dB(A)]									
2	60	52	56	51	50	53	48	39	34
3	53	34	36	44	46	50	39	37	32
4	55	31	35	42	48	53	40	36	30
5	54	33	39	46	48	51	44	39	34

Pkt. Pracy	Częstotliwości pasm oktaowych [Hz]								
	tot	63	125	250	500	1000	2000	4000	8000
L_{WA} wlot [dB(A)]									
2	84	59	70	73	77	81	76	70	62
3	88	45	54	70	75	79	86	72	65
4	88	40	50	70	73	80	87	73	66
5	87	45	52	69	76	82	85	75	69
L_{WA} wylot [dB(A)]									
2	87	59	71	75	79	83	80	73	65
3	87	47	55	73	77	80	85	74	66
4	88	38	49	72	77	81	86	75	68
5	88	43	53	71	79	83	85	77	71
L_{WA} od obudowy [dB(A)]									
2	67	58	59	54	52	64	51	44	38
3	61	49	46	47	49	58	52	44	38
4	61	54	45	45	47	59	52	44	39
5	62	51	44	47	50	60	52	46	41

charakterystyki pracy

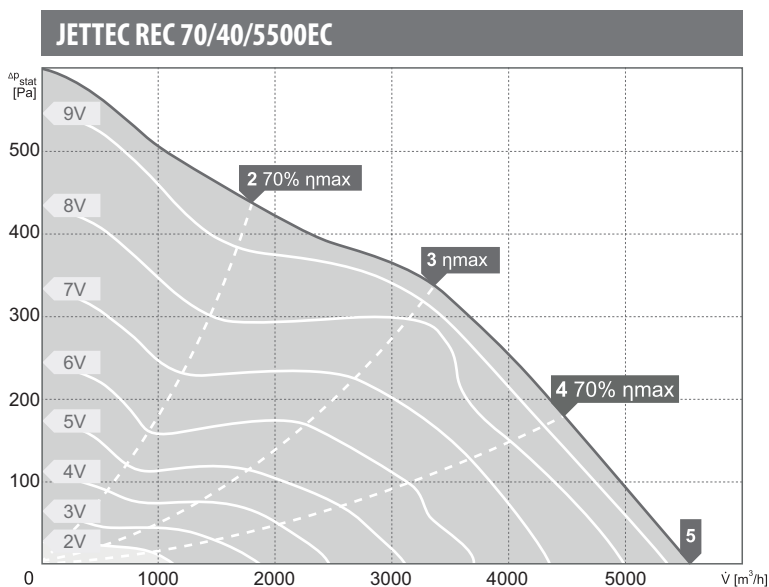
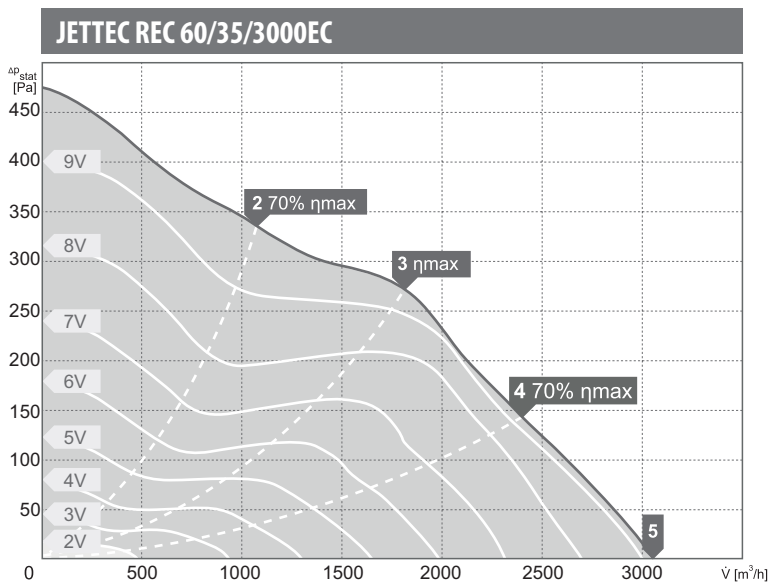
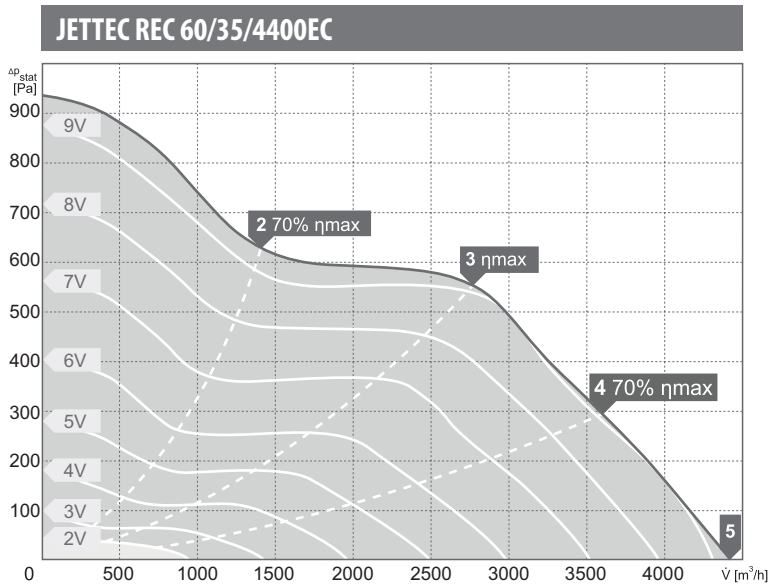

wartości mocy akustycznej L_{WA} [dB(A)]

dla poszczególnych częstotliwości pasm oktaowych [Hz]

Pkt. Pracy	Częstotliwości pasm oktaowych [Hz]								
	tot	63	125	250	500	1000	2000	4000	8000
L_{WA} wlot [dB(A)]									
2	86	66	74	75	81	81	79	74	63
3	82	51	50	69	75	77	75	74	67
4	81	53	50	68	74	75	75	74	68
5	84	57	50	70	75	78	77	76	71
L_{WA} wylot [dB(A)]									
2	90	67	74	77	85	85	81	76	65
3	86	56	58	74	81	82	79	75	66
4	85	48	50	72	79	80	78	75	69
5	87	60	51	72	81	83	81	78	72
L_{WA} od obudowy [dB(A)]									
2	66	59	63	56	57	54	49	46	41
3	64	55	59	55	57	53	49	46	40
4	57	41	43	50	52	50	47	44	39
5	59	46	44	49	55	53	50	47	42

Pkt. Pracy	Częstotliwości pasm oktaowych [Hz]								
	tot	63	125	250	500	1000	2000	4000	8000
L_{WA} wlot [dB(A)]									
2	78	55	63	68	74	73	70	64	53
3	74	33	49	61	68	69	67	66	56
4	73	32	43	56	67	67	66	66	54
5	75	33	45	61	69	70	69	68	58
L_{WA} wylot [dB(A)]									
2	81	55	64	70	76	77	72	66	55
3	75	30	47	63	70	71	68	66	56
4	75	28	43	60	70	70	68	66	55
5	78	32	46	62	71	73	71	69	59
L_{WA} od obudowy [dB(A)]									
2	62	57	59	49	50	51	48	44	36
3	55	37	44	45	48	48	47	46	37
4	54	30	38	41	48	47	47	47	36
5	55	32	39	42	47	49	49	50	40

Pkt. Pracy	Częstotliwości pasm oktaowych [Hz]								
	tot	63	125	250	500	1000	2000	4000	8000
L_{WA} wlot [dB(A)]									
2	86	59	69	73	78	79	83	71	62
3	81	36	53	70	73	76	73	72	64
4	80	35	49	66	72	77	73	73	63
5	83	36	52	68	75	79	78	75	67
L_{WA} wylot [dB(A)]									
2	90	58	70	76	80	82	89	73	63
3	81	35	53	71	75	77	75	72	64
4	83	36	50	70	75	79	76	73	64
5	86	39	53	74	80	81	80	76	68
L_{WA} od obudowy [dB(A)]									
2	66	59	60	55	52	57	58	49	51
3	57	38	46	50	49	52	47	47	48
4	55	39	35	45	47	51	46	43	34
5	57	39	40	48	49	53	48	45	37

charakterystyki pracy

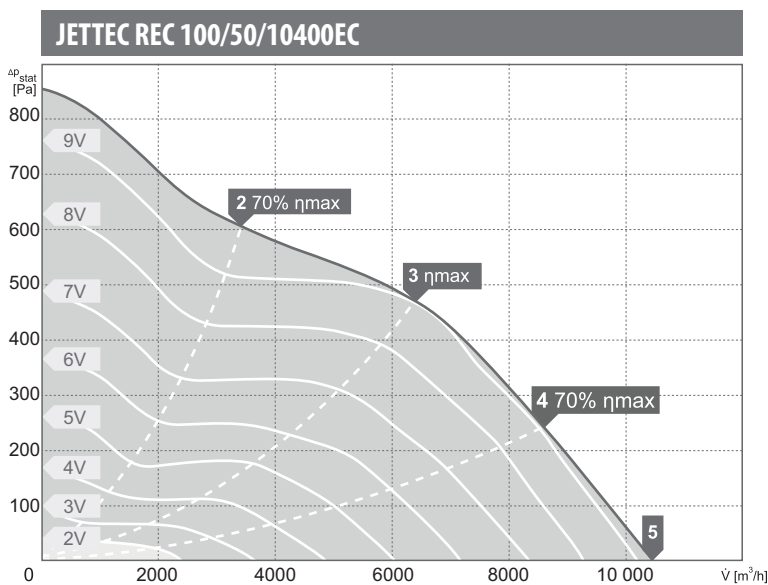
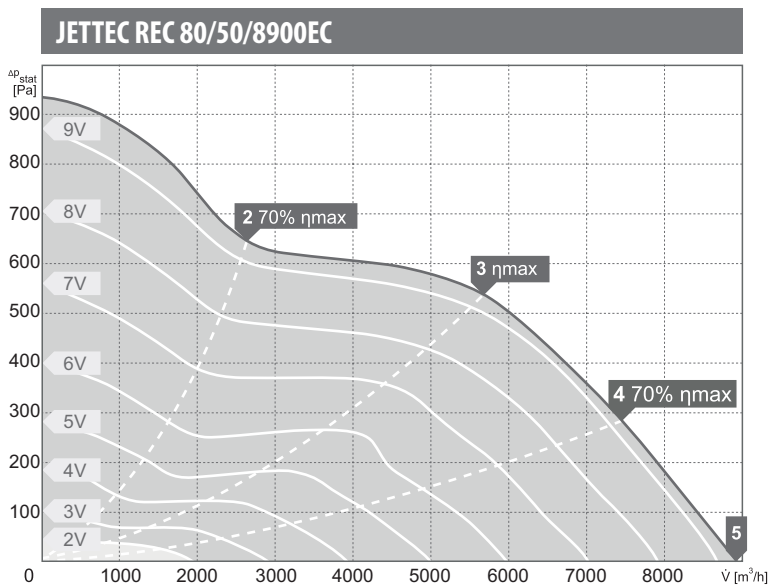
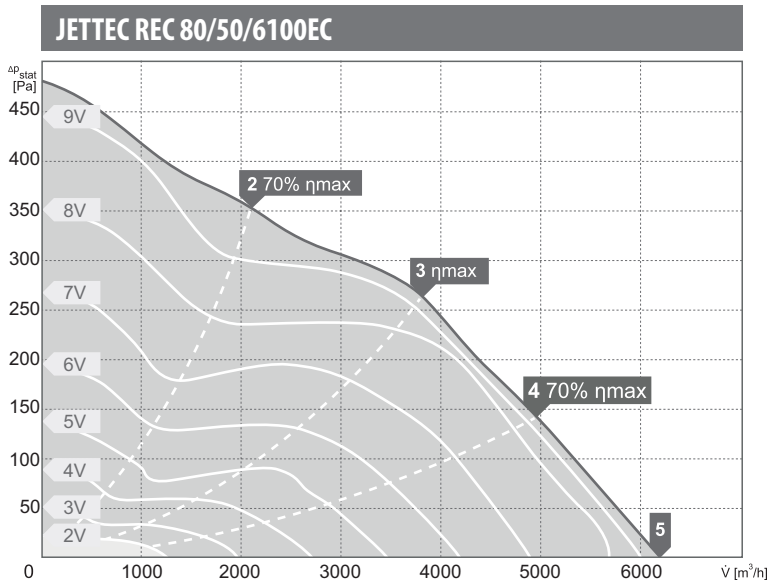

wartości mocy akustycznej L_{WA} [dB(A)]
dla poszczególnych częstotliwości pasm oktaowych [Hz]

Pkt. Pracy	tot	Częstotliwości pasm oktaowych [Hz]							
		63	125	250	500	1000	2000	4000	8000
L_{WA} wlot [dB(A)]									
2	80	56	65	70	76	76	72	67	56
3	78	38	54	65	73	74	71	69	58
4	78	34	48	61	71	74	71	70	57
5	80	36	49	63	74	76	74	72	61
L_{WA} wylot [dB(A)]									
2	83	56	66	73	78	79	75	68	57
3	82	51	61	71	77	78	74	70	59
4	81	36	50	65	74	77	73	70	59
5	83	43	51	68	77	79	76	73	62
L_{WA} od obudowy [dB(A)]									
2	61	58	56	52	51	48	42	36	27
3	55	46	42	47	52	44	39	36	26
4	54	43	36	43	52	44	39	36	26
5	58	43	39	44	57	47	43	39	30

Pkt. Pracy	tot	Częstotliwości pasm oktaowych [Hz]							
		63	125	250	500	1000	2000	4000	8000
L_{WA} wlot [dB(A)]									
2	89	62	74	77	83	84	81	76	66
3	86	44	58	76	80	81	79	77	69
4	86	43	55	73	78	81	80	78	71
5	87	44	56	74	79	82	81	80	73
L_{WA} wylot [dB(A)]									
2	92	59	74	80	87	88	85	80	71
3	89	45	58	77	83	85	83	79	70
4	89	41	55	75	82	84	84	80	73
5	92	47	57	78	84	87	86	83	76
L_{WA} od obudowy [dB(A)]									
2	69	63	66	59	57	57	52	53	52
3	61	44	50	53	53	54	49	50	49
4	58	42	50	48	50	52	48	47	42
5	59	41	49	49	52	53	49	49	43

Pkt. Pracy	tot	Częstotliwości pasm oktaowych [Hz]							
		63	125	250	500	1000	2000	4000	8000
L_{WA} wlot [dB(A)]									
2	89	64	75	77	84	84	81	75	67
3	84	39	57	74	78	79	77	75	67
4	84	38	55	71	77	79	78	77	68
5	86	42	56	72	80	80	79	78	70
L_{WA} wylot [dB(A)]									
2	92	64	74	78	88	88	84	78	69
3	91	58	71	79	86	86	82	78	69
4	89	42	56	75	83	84	81	79	70
5	90	45	58	77	85	86	83	81	73
L_{WA} od obudowy [dB(A)]									
2	73	59	65	62	66	66	67	61	52
3	68	44	51	56	60	61	63	60	50
4	69	46	53	57	61	61	64	62	52
5	71	47	55	60	63	63	66	64	56